



SKYLIGHT

DO JOYOUS PHOTON

ALL THE UNHAPPINESS DISAPPEARED
WHEN LOOKING UP TO THE SKY.



PRODUCT INFORMATION

PRODUCT DIMENSIONS	1794X400X175MM
N. WEIGHT	17.4KG
G. WEIGHT	25KG
PACKAGE DIMENSIONS	1820X440X240MM

Installation Note:

Please mounting the Light close to the wall.

Make sure the Light's **Illuminant Direction** is **against** the wall.

**Dimensions may slightly different depend on the versions.

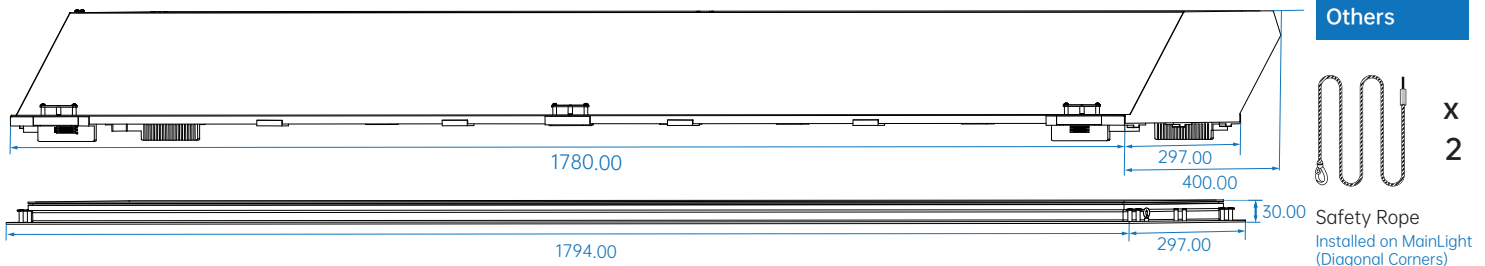

Unite: Millimeter (mm)

Front Veiw

Side Veiw

Note

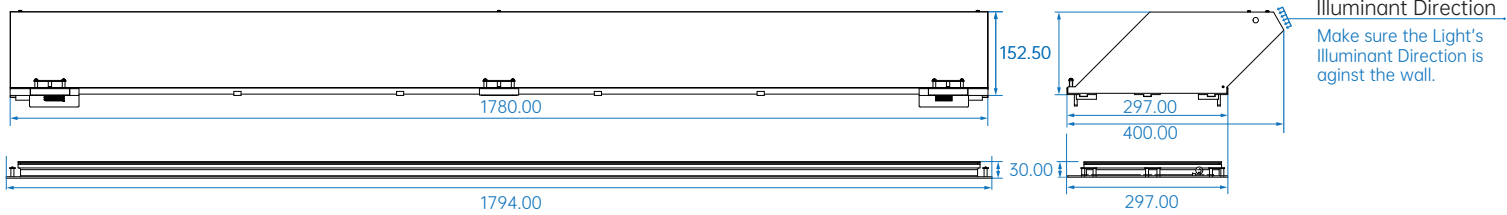

TECHNICAL INFORMATION

ORDER CODE	AL003-WMD-16WC Adjustable Brightness and Color Temperature
VERSIONS AVAILABLE	Smart
INPUT VOLTAGE	100 - 240V~ 50/60Hz
POWER INPUT	180 W (Max)
POWER CONSUMPTION	2 channels (108V DC 1600mA)
TOTAL LIGHT OUTPUT	2700 lm - 5000 lm
CCT RANGE	1800 K - 10000 K
CERTIFICATION	CE, RoHS, SAA, ENEC, TUV, CB, CETL,ETL,PSE (In Progress)
FRAME CORNICE	The frame can be Recessed Mounted, Grid Ceiling Mounted.

RESET & DIMMER PAIRING AL003-WMD-16WC

Light Reset:

If the light adding unsuccessful, you need to reset it. Please turn ON the light for 2 seconds, and turn OFF for 4 seconds, and repeat the same steps for 5 times.

Light Pairing with Dimmer

If the Light attached with a Dimmer, Please use the App to add the Light first, then add the Dimmer: After installing the Dimmer according to the dimmer instructions, put the shredders dial and place it on "ON", Waiting for 2 minutes, until the Dimmer's internal capacitor fully charged, long press the reset buttons inside the Dimmer for 5 seconds, and you can use the App to add the Dimmer.

APP INSTRUCTION

DOWNLOAD

1. Download the app from the App Store by searching " PeseTech";
2. Scan the QR code below to download the App.

APP INSTRUCTION (SIMPLIFIED)

1. Go to the app and login, if you did not have an account, you can register first;
2. Click the "+" Button and follow the guide instruction to complete the Device Online;
3. Once the device gets connected, please go to the device main page by click the device icon;
4. The Skylight is a multifunctional light. In the main page, it offers 6 functions:

- CCT: Adjustable CCT and Brightness Value.
- Classic: 9 CCT and Brightness preset Values.
- Scene: 8 Scene Modes presets.
- Auto: Adjustable Auto Turn ON/OFF (Smoothly).
- HCL: Adjustable Human Centric Lighting.
- Schedule: Adjustable Turn ON/OFF Timer.



iOS



Android

VERSIONS INTRO

UND DAD WMD

- | | | | |
|---|---|---|--|
| ■ | ■ | ■ | 1. Dual mode light uses AC 100-240V voltage. Please switch off power supply when installing. |
| ■ | ■ | ■ | 2. Do not use water to spray or wash light, also please do not install light in the humid or dripping place, in case of electricity leakage. |
| | | ■ | 3. Dual mode light's response time operates according to internal real-time clock. When used App at the first time, App will correct clock automatically. |
| | | ■ | 4. If the light wasn't used for more than one month, internal real-time clock will disorder. Please use App in the range of lighting control, then App will correct clock automatically. |
| | | ■ | 5. After matched with light, user needs corresponding wireless bluetooth dimmer to control light-on or light-off and light's brightness. |
| | | ■ | 6. Light consists of precise parts, please do not detach or change it by yourself. There is wireless receiving antenna in driver, thus if there is metal barrier in installation environment, controlling signal will be weakened. |
| | | ■ | 7. This light uses WIFI to communication with server , so please try to keep distance no more than 20 meters between light and router. If there was metal barrier or other electric device to disturb, which willshorten communication distance. In this situation, user can shorten the distance between light and router to improve. |
| | | ■ | 8. Alarm-clock settings of light should not exceed 5 time tacks. |
| | | ■ | 9. HCL setting of light should not exceed 15 time tasks. |
| | | ■ | 10. This light is dual-mode signal communication. If the ceiling light surroundings had no other bluetooth mesh device, user can control it by WIFI. |

BEFORE INSTALLATION

NOTE:

Please mounting the Light close to the wall.

Make sure the Light's **Illuminant Direction** is **against** the wall.

RECESSED MOUNTED

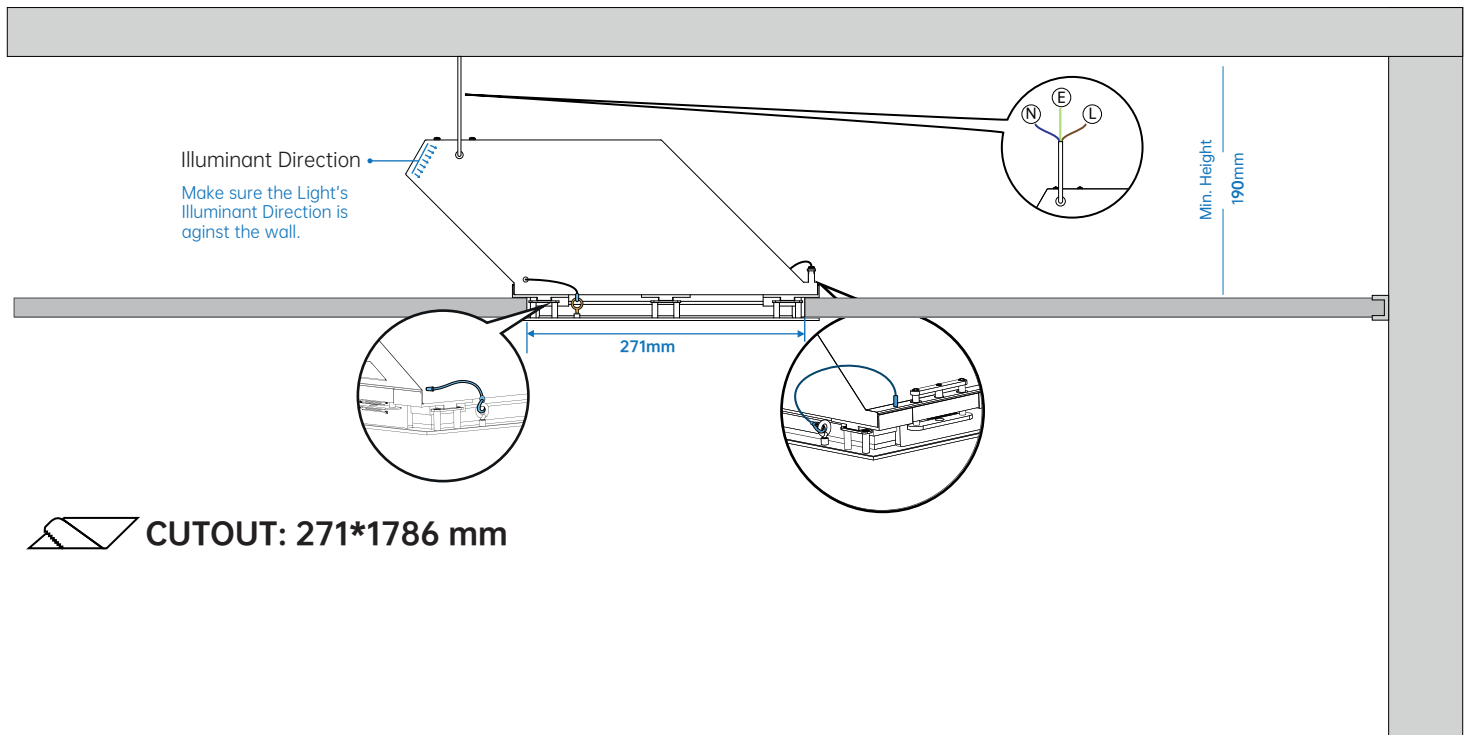

GRID CEILING MOUNTED

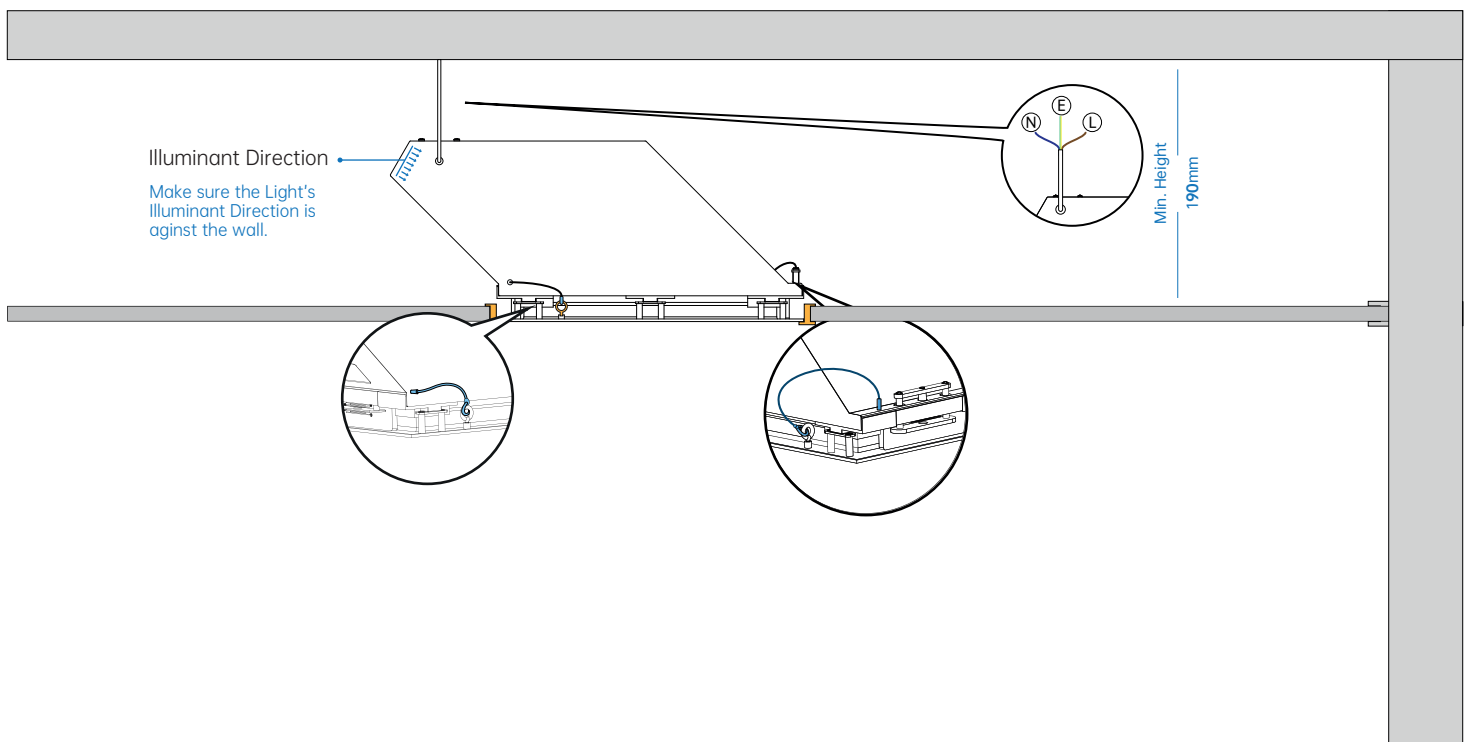

RECESSED MOUNTED

CUTOUT: 271 * 1786 mm

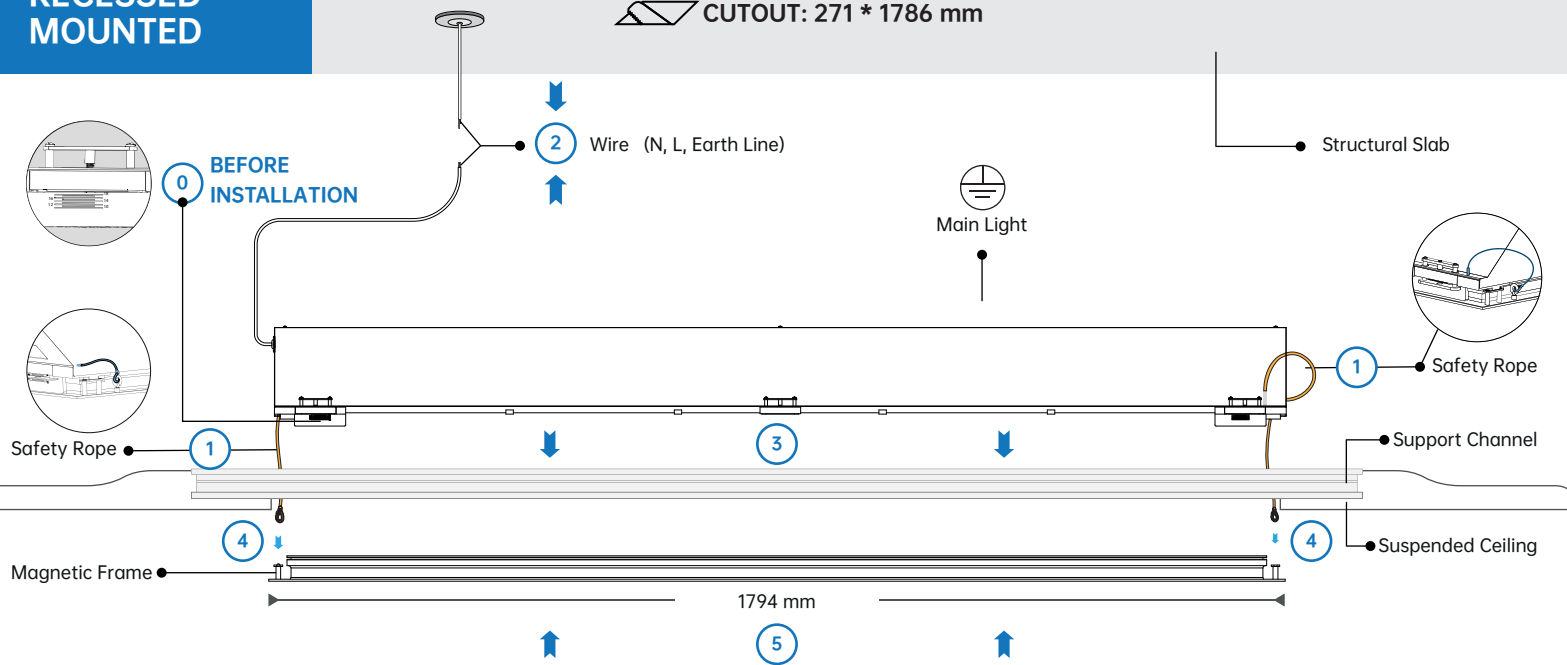

INSTALLATION

MULTIPLE LIGHTS CAN BE INSTALLED IN SERIAL

BEFORE INSTALLATION

0 Rotate screw to adjust the distance to match the Ceiling Thickness. (Max. 20mm)

SAFETY ROPES

1 The Safety Ropes were installed on the Main Light's Diagonal Corners.

POWER LINE

2 Connect the Wires to Power Line. (Be sure to Turn OFF Power while installing)

MAIN LIGHT

3 Push the Main Light into the Suspended Ceiling and set on the Support Channel.

MAGNETIC FRAME

4 Link the Other side of the Safety Ropes to the Magnetic Frame.

5 Push the Magnetic Frame to cover the Suspended Ceiling.



SAFETY ROPES
(INSTALLED ON MAINLIGHT)

FINISHED

CUTOUT: 271 * 1786 mm

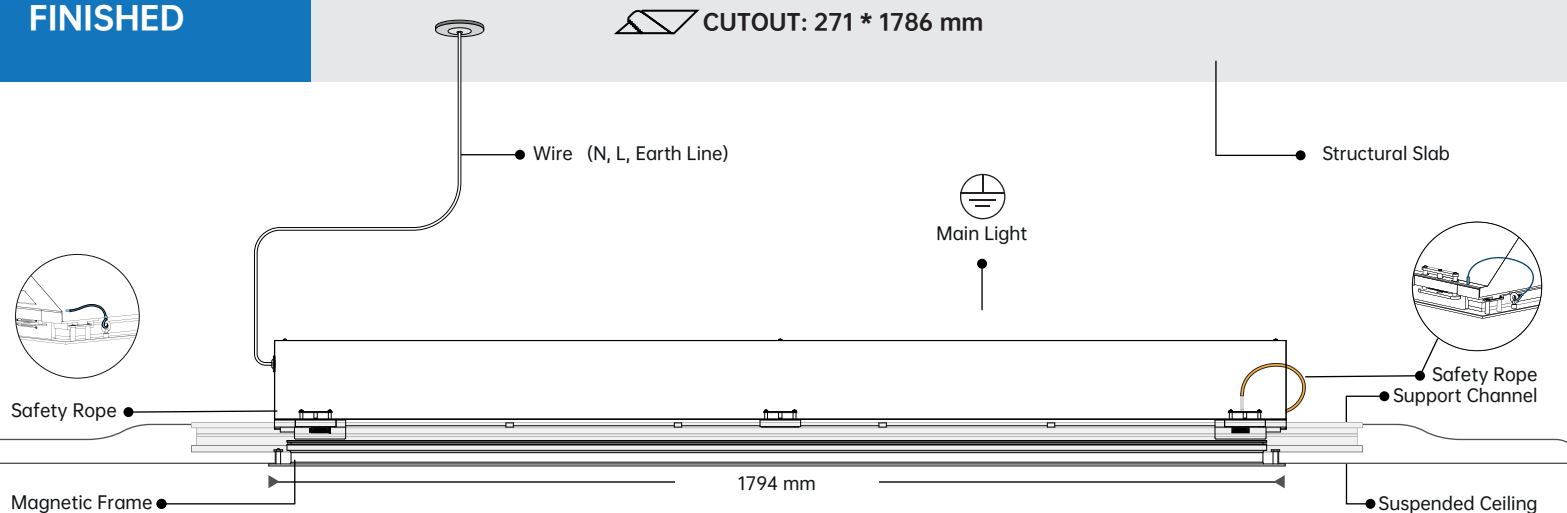

GRID CEILING MOUNTED

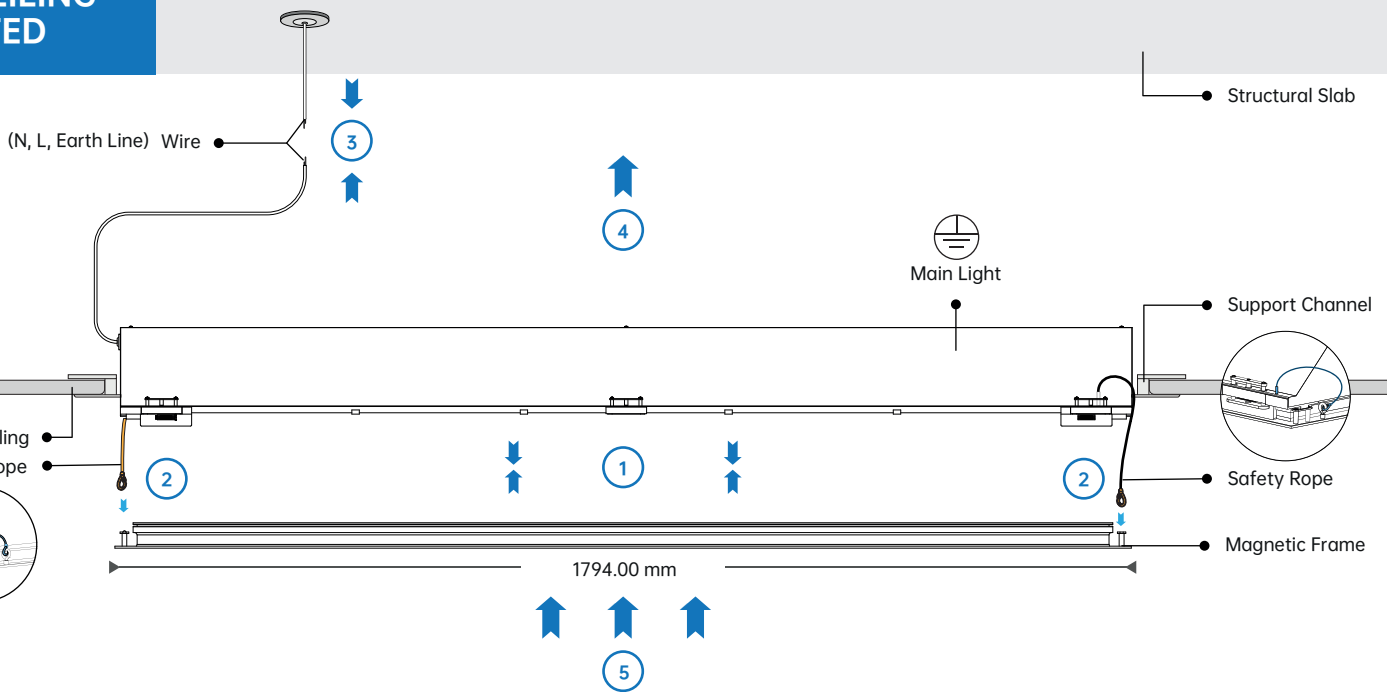

INSTALLATION

MULTIPLE LIGHTS CAN BE INSTALLED IN SERIAL

● MAIN LIGHT

① Let the Magnetic Frame stick on the Main Light.

● SAFETY ROPES

② The Safety Ropes were installed on the Main Light's Diagonal Corners. Use the Safety Ropes to connect the Magnetic Frame.

● POWER LINE

③ Connect the Wires to Power Line. (Be sure to Turn OFF Power while installing)

● MAGNETIC FRAME

④ Push the Whole Light (Main Light and Magnetic Frame) into the PlasterBoard Ceiling.

⑤ Let the Whole Light Settle on the Support Channel.

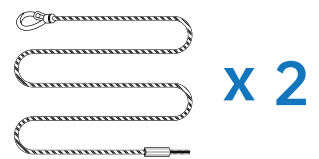

SAFETY ROPES
(INSTALLED ON MAINLIGHT)

GRID CEILING MOUNTED

